

Programmable Attenuator

RC8DAT-8G-95

50Ω 0 – 95 dB, 0.25 dB step 1 to 8000 MHz

The Big Deal

- Eight independently programmable channels
- Over 100 dB Isolation between channels
- Supports U-NII bands 5-8 (5.925 to 7.125 GHz)
- Fine attenuation resolution, 0.25 dB
- Automation via Ethernet & USB

Applications

- Wi-Fi 6E MIMO development
- LTE / 5G / IoT / Bluetooth / Zigbee
- Cellular handover testing
- C-band radar / satcom testing
- Automated signal sweeping / fading



Case Style: QE2899

Included Accessories

Model No.	Description	Qty.
USB-CBL-AC-3+	3.3 ft. USB cable	1

RoHS Compliant

See our web site for RoHS Compliance methodologies and qualifications

Product Overview

Mini-Circuits' RC8DAT-8G-95 is an 8-channel programmable attenuator suitable for a wide range of signal level control applications from 1 MHz to 8 GHz. Each independently controlled channel provides 0 to 95 dB attenuation in 0.25 dB steps with more than 100 dB isolation between channels. Its unique design maintains linear attenuation change per dB, even at the highest attenuation settings.

All 8 bi-directional RF channels are housed in a single, compact and rugged package with SMA female connectors on all RF ports, a standard Ethernet port (RJ45) and a USB type C power and control port.

The attenuator can be controlled via USB or Ethernet (supporting HTTP, Telnet and SSH network protocols). Full software support is provided and can be downloaded from our website any time at <http://www.minicircuits.com/softwaredownload/patt.html>. The package includes our user-friendly GUI application for Windows® and a full API with programming instructions for Windows® and Linux® environments (both 32-bit and 64-bit systems).

Key Features

Feature	Advantages
USB & Ethernet control	USB HID and Ethernet (HTTP / Telnet / SSH) interfaces provide easy compatibility with a wide range of software setups and programming environments. The device draws all power requirements through the USB port.
Programmable attenuation sweep and Hop sequences	The RC8DAT-8G-95 can be programmed with a timed sequence of attenuation settings, to run without any additional external control with fast transitions of 650 ns Typ.
95 dB attenuation range	The RC8DAT-8G-95 provides high-accuracy attenuation up to 95 dB, allowing the user precise level control over a broad attenuation and frequency range.
Safe attenuation transitions	The RC8DAT-8G-95 is designed to prevent any momentary positive 'spikes' in power during attenuation transitions
High linearity	Typical input IP3 of +51 dBm up to 8000 MHz

Trademarks: Windows is a registered trademark of Microsoft Corporation in the United States and other countries. Linux is a registered trademark of Linus Torvalds. Mac is a registered trademark of Apple Corporation. Pentium is a registered trademark of Intel Corporation. Neither Mini-Circuits nor the Mini-Circuits RC8DAT-series attenuators are affiliated with or endorsed by the owners of the above referenced trademarks.

Mini-Circuits and the Mini-Circuits logo are registered trademarks of Scientific Components Corporation.

Rev. OR
M176944
EDR-11765/5
RC8DAT-8G-95
RAV
200930
Page 1 of 11



Electrical Specifications ^{1,2} at +25°C

Parameter	Frequency range	Conditions	Min.	Typ.	Max.	Units
Attenuation range	1 - 7200 MHz	0.25 dB step	0	-	95	dB
	7200 - 8000 MHz		0	-	90	
Attenuation accuracy ³	1 - 2000 MHz	@ 0.25 - 20 dB	-0.7	0.4	0.4+4% of nominal value	dB
		@ 20.25 - 60 dB	-0.5	1.7	0.4+4.5% of nominal value	
		@ 60.25 - 80 dB	-0.5	3.0	-0.4+6% of nominal value	
		@ 80.25 - 95 dB	-0.3	3.7	-3.6+10% of nominal value	
	2000 - 4000 MHz	@ 0.25 - 60 dB	-0.7	1.0	0.4+4% of nominal value	
		@ 60.25 - 80 dB	-1.2	2.0	-1.0+6.5% of nominal value	
		@ 80.25 - 95 dB	-1.2	2.8	-3.0+9% of nominal value	
	4000 - 6000 MHz	@ 0.25 - 20 dB	-0.4-5% of nominal value	-0.2	0.75	
		@ 20.25 - 60 dB	-0.5-4.5% of nominal value	-0.6	0.5+1.5% of nominal value	
		@ 60.25 - 80 dB	-0.2-5% of nominal value	-1.7	0.5+1.5% of nominal value	
		@ 80.25 - 95 dB	3-9% of nominal value	-2.3	0.5+1.5% of nominal value	
	6000 - 7200 MHz	@ 0.25 - 20 dB	-0.4-5% of nominal value	-0.5	0.7	
		@ 20.25 - 60 dB	-0.5-4.5% of nominal value	-1.8	0.5	
		@ 60.25 - 80 dB	0.4-6% of nominal value	-3.0	0.9	
		@ 80.25 - 95 dB	3.6-10% of nominal value	-3.7	0.9	
	7200 - 8000 MHz	@ 0.25 - 20 dB	-0.5-5.5% of nominal value	-0.6	0.3	
		@ 20.25 - 60 dB	-0.8-4.5% of nominal value	-2.1	0.3	
		@ 60.25 - 80 dB	-0.7-4.5% of nominal value	-2.7	0.2+2% of nominal value	
		@ 80.25 - 90 dB	-0.7-4.5% of nominal value	-2.9	-1.7+6% of nominal value	
	Insertion Loss	1 - 2000 MHz	@ 0 dB	-	4.2	
2000 - 4000 MHz		-		5.6	8.0	
4000 - 6000 MHz		-		7.4	9.0	
6000 - 7200 MHz		-		8.3	11.5	
7200 - 8000 MHz		-		10	12.0	
Isolation In - Out (within a channel)	1 - 8000 MHz	Note 4	-	100	-	dB
Isolation (between channels) ⁵	1 - 8000 MHz	@ 0 - 95 dB	100	125	-	
Input operating power ⁶ (RF In and RF Out out ports)	1 - 50 MHz	@ 0 - 95 dB	-	-	Note 7	dBm
	50 - 8000 MHz		-	-	+28	
IP3 Input ⁸	1 - 5000 MHz	@ 0 dB setting	-	+53	-	dBm
	5000 - 8000 MHz	(P _{IN} =+5 dBm)	-	+48	-	
VSWR	1 - 2000 MHz	@ 0 - 95 dB	-	1.15	-	:1
	2000 - 4000 MHz	@ 0 - 95 dB	-	1.20	-	
	4000 - 6000 MHz	@ 0 - 95 dB	-	1.25	-	
	6000 - 7200 MHz	@ 0 - 95 dB	-	1.50	-	
	7200 - 8000 MHz	@ 0 - 95 dB	-	1.80	-	
Min Dwell Time per channel ⁹	1 - 8000 MHz	High speed mode	-	600	-	µsec
Channel Synchronization ¹⁰	1 - 8000 MHz	Note 9	-	400	-	µsec
Attenuation Transition Time ¹¹	1 - 8000 MHz	-	-	650	-	nsec
Supply Voltage	-	via USB port	4.75	5	5.25	V
USB current draw	-	-	-	210	330	mA
Ethernet Communication	Protocol	TCP / IP, HTTP, Telnet, DHCP, UDP (limited), SSH				
	Max Data Rate	100 Mbps (100 Base-T Full Duplex)				
USB Communication	Protocol	HID (Human Interface Device) - High Speed				
	Min Communication Time ¹²	400 µs typ (full transmit/recieve cycle)				

¹ Attenuator RF ports are interchangeable, and support simultaneous, bidirectional signal transmission, however the specifications are guaranteed for the RF in and RF out as noted on the label. There may be minor changes in performance when injecting signals to the RF Out port.

² RF performance specified per channel, performance of all four channels is identical.

³ Min/Max accuracy defined as [absolute error+% of attenuation setting] for example when setting the attenuator to 90 dB attenuation the maximum error at 7500 MHz will be Min=(-0.7-0.045x90)= (-0.7-4.05)= -4.75 dB, Max=(-1.7+0.06*90)=(-1.7+5.4)=3.7 dB, meaning actual attenuation will be in the 93.7 to 85.25 dB range.

⁴ Isolation In-Out is defined as max attenuation plus insertion loss; this is the path loss through the attenuator when initially powered up. After a brief delay (~0.5 sec typically) the attenuator will revert to a user defined "power-up" state (either max attenuation or a pre-set value).

⁵ Isolation between channels may drop to 95 dB when both channels being tested are at 0 dB attenuation state.

⁶ Total operating input power per channel from both RF In and RF Out out ports. Compression level not noted as it exceeds max safe operating power level.

⁷ Derate linearly from +28 dBm at 50 MHz to +17 dBm at 1MHz.

⁸ Tested with 1 MHz span between signals.

⁹ Minimum Dwell Time is the time the RC8DAT will take to respond to a command to change attenuation states in a channel without communication delays. In PC control add communication delays (on the order of msec for USB) to get actual response time.

¹⁰ Channel Synchronization is the delay between the first and last attenuator transitions beginning, in response to a command to set all channels.

¹¹ Attenuation Transition Time is specified as the time between starting to change the attenuation state and settling on the requested attenuation state.

¹² USB min communication time is based on the polling interval of the USB HID protocol(125 µs polling interval, 1024 bytes per packet), medium CPU load and no other high speed USB devices using the USB bus.

RC8DAT response to communication interrupt

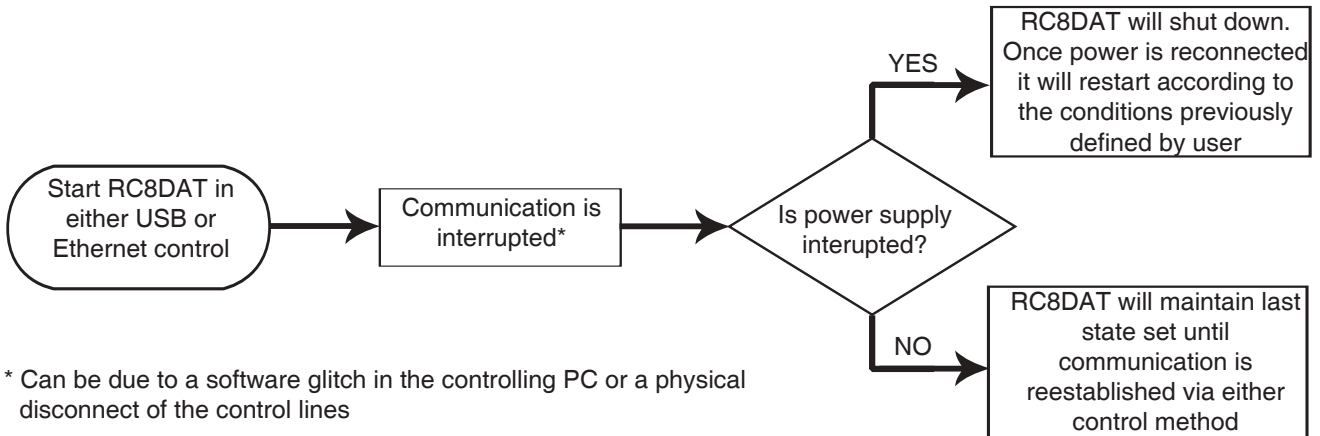

Block Diagram

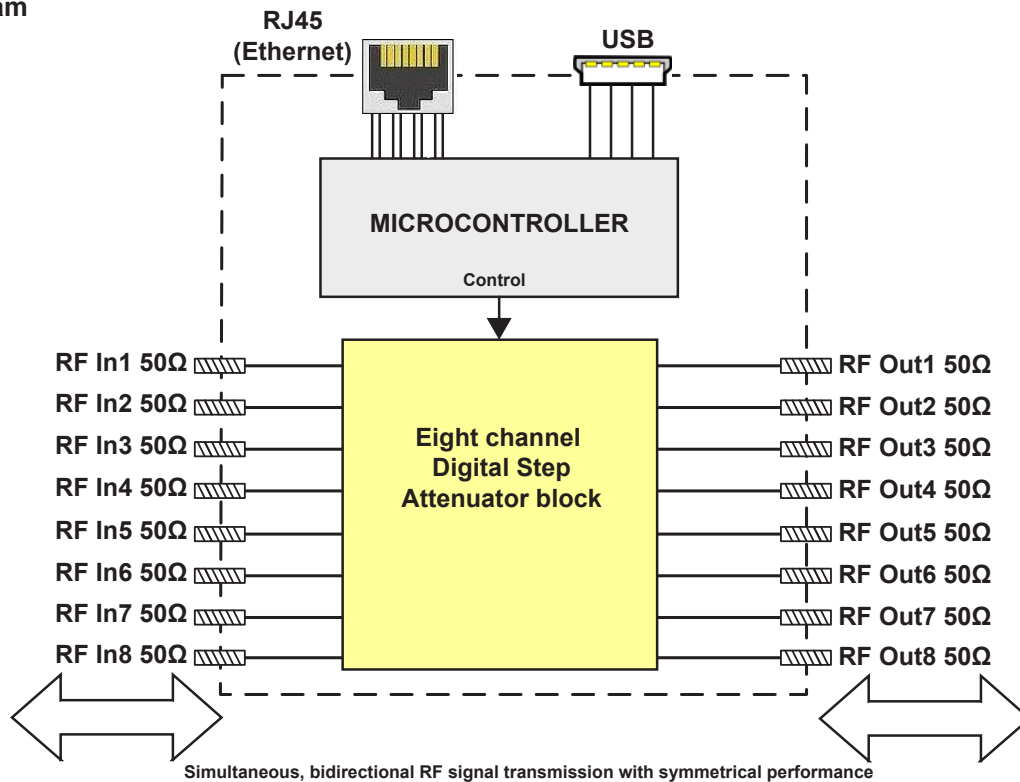

Connections

RF In 1,2,3,4,5,6,7,8	(SMA female)
RF Out 1,2,3,4,5,6,7,8	(SMA female)
USB	(USB type C female)
Network (Ethernet/LAN)	(RJ45 socket)

Absolute Maximum Ratings

Operating Temperature	0°C to 50°C	
Storage Temperature	-20°C to 85°C	
V _{USB} Max.	6V	
DC voltage at RF port	16V	
Total RF power for RF In & RF Out	@ 1 - 50 MHz	Derates linearly from +33 @ 50 MHz to +20 @ 1 MHz
	@ 50 - 8000 MHz	

Permanent damage may occur if any of these limits are exceeded. Operating in the range between operating power limits and absolute maximum ratings for extended periods of time may result in reduced life and reliability.

Outline Drawing (QE2899)

Connections

RF IN 1, 2, ,3, 4,5,6,7,8	(SMA female)
RF OUT 1, 2, ,3, 4,5,6,7,8	(SMA female)
USB	(USB type C female)
Network (Ethernet/LAN)	(RJ45 socket)

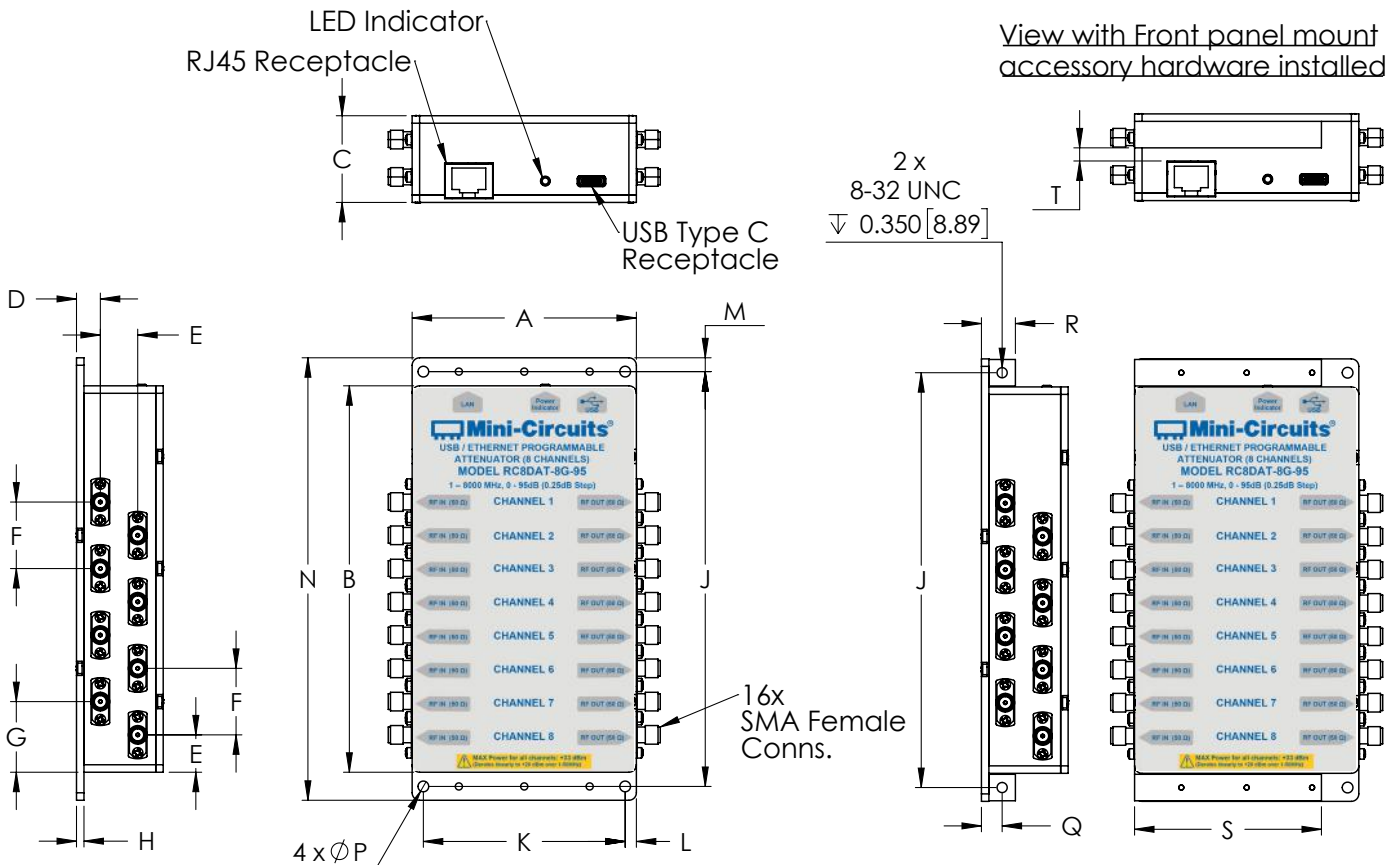

For bracket mounting instructions see page 5

Outline Dimensions (inch mm)

A	B	C	D	E	F	G	H	J	K	L	M	N	P	Q	R	S	T	WT. GRAMS
3.00	5.17	1.16	0.319	0.500	0.89	0.945	0.100	5.550	2.700	0.150	0.185	5.92	0.144	0.277	0.454	2.500	0.176	700
76.2	131.3	29.5	8.10	12.70	22.6	24.00	2.54	140.97	68.58	3.81	4.70	150.4	3.66	7.04	11.54	65.50	4.46	

Tolerances: inch 2PL. ±0.03 3PL. ±0.015
mm 1PL. ±0.8 2PL. ±0.38



Bracket mounting instruction (for side mounting the attenuator to front panel of rack)

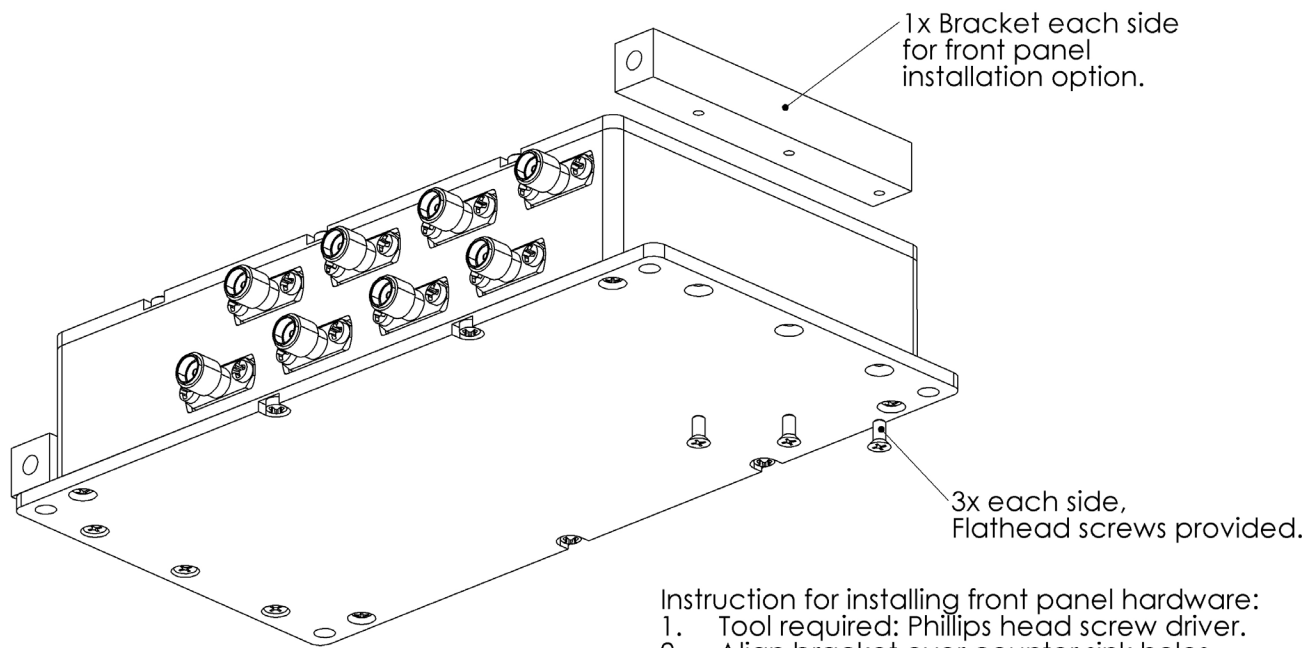

- Instruction for installing front panel hardware:
1. Tool required: Phillips head screw driver.
 2. Align bracket over counter sink holes.
 3. Secure with screws provided.

Note: Bracket can be mounted facing opposite direction, as needed.

Typical Performance Curves *

*at +25°C unless noted otherwise

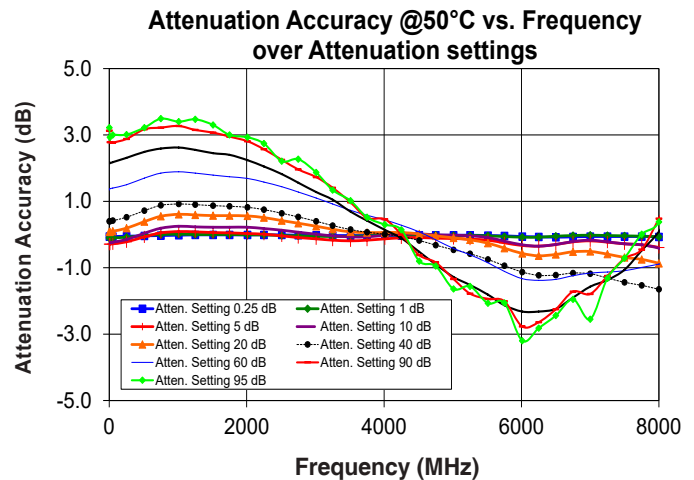
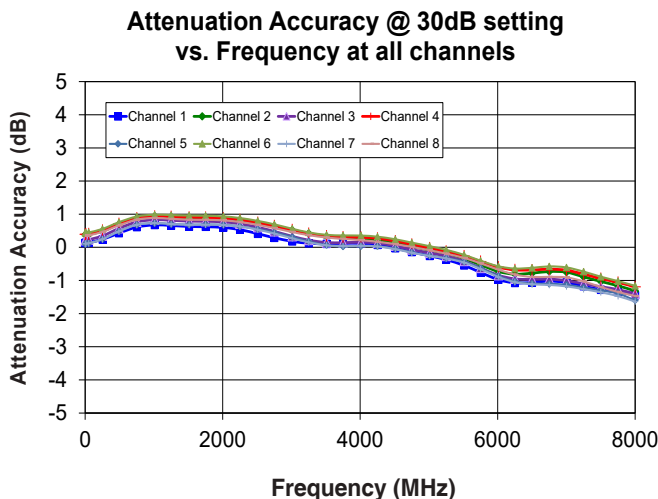
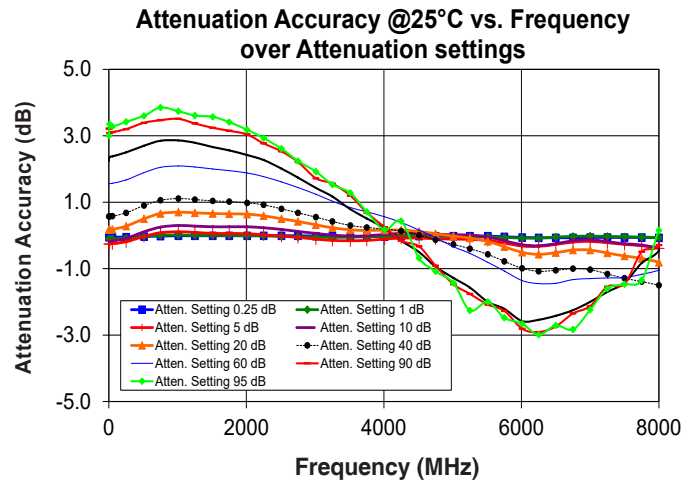
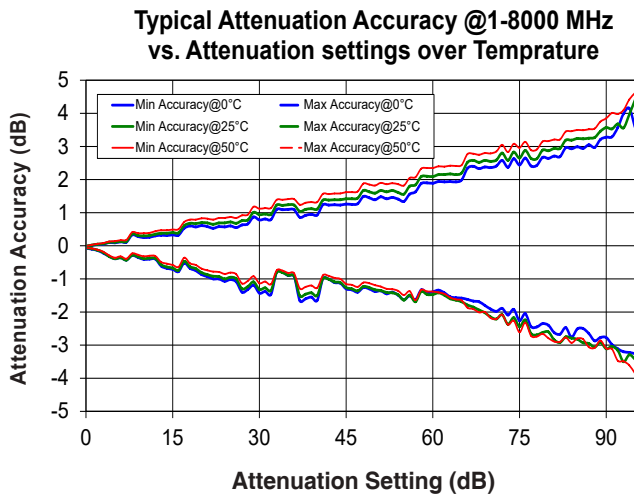
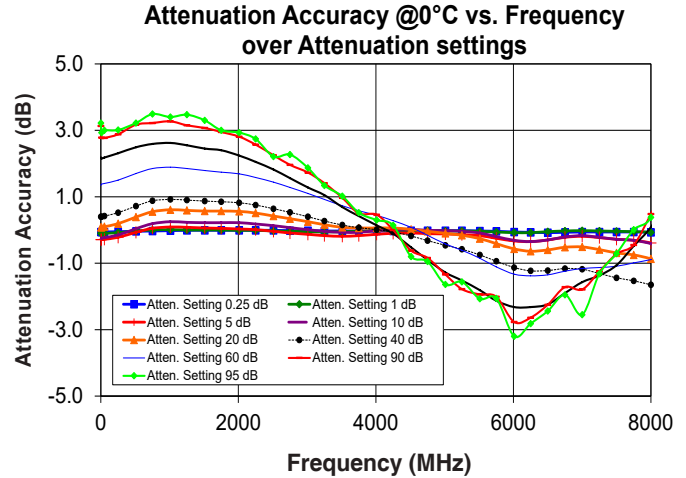
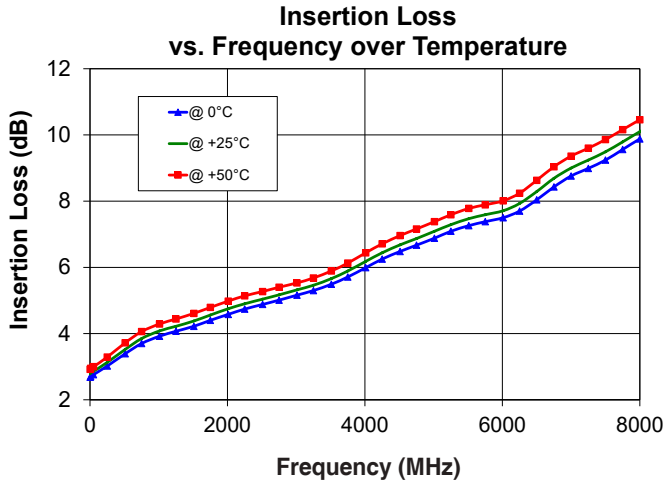

Typical Performance Curves (Continued) *

*at +25°C unless noted otherwise

Attenuation Accuracy @ 60dB setting vs. Frequency at all channels

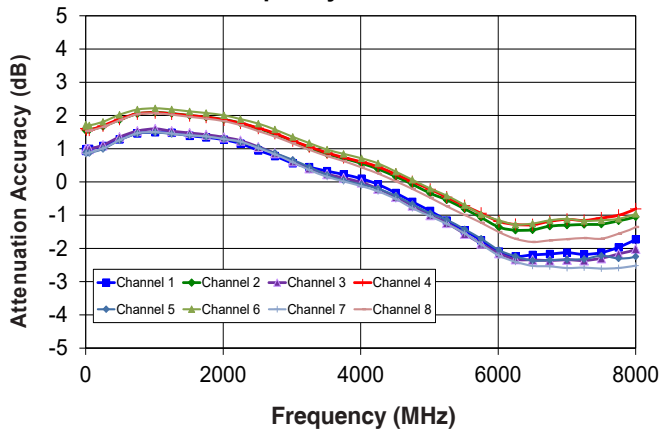

Attenuation Accuracy @ 90dB setting vs. Frequency at all channels

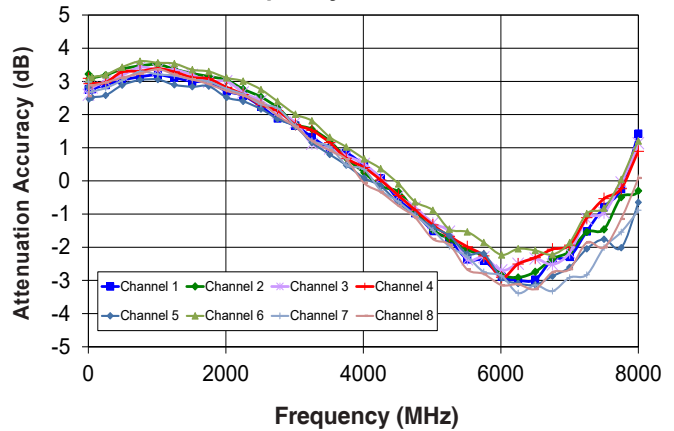

Input VSWR vs. Frequency over Attenuation settings

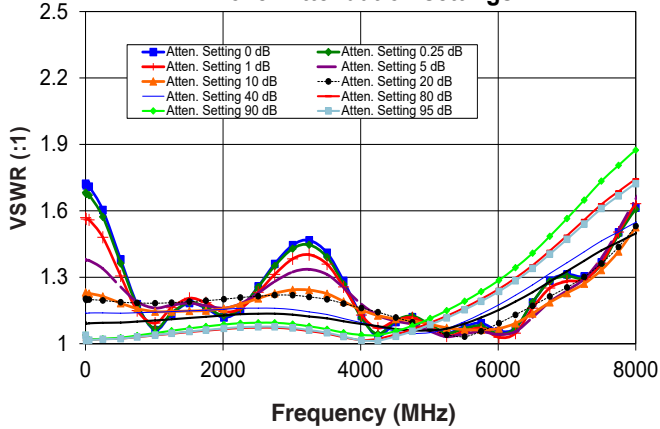

Output VSWR vs. Frequency over Attenuation settings

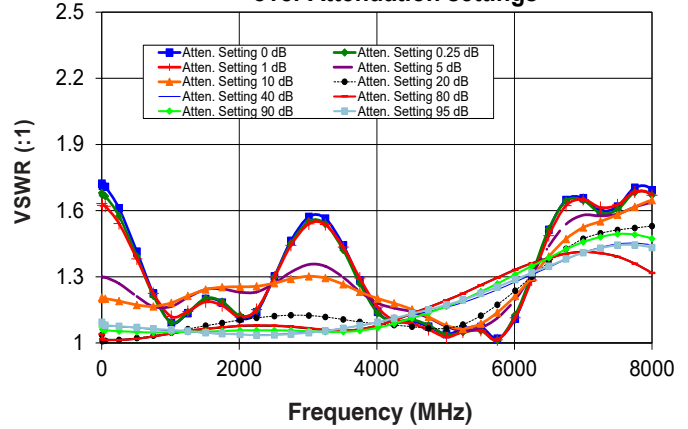

Isolation between channels vs. Frequency

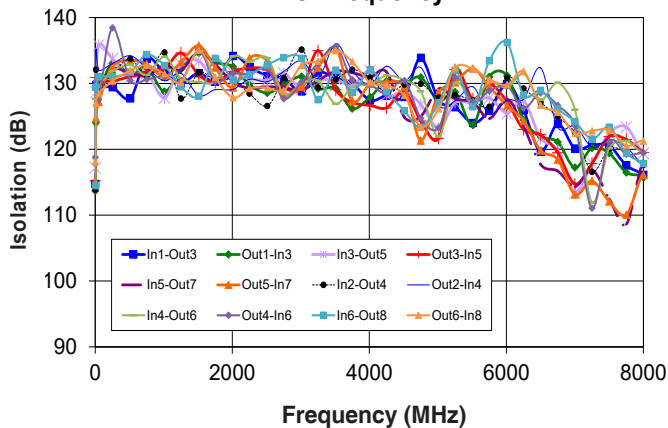

IP3 @ 0dB Attenuation vs. Frequency

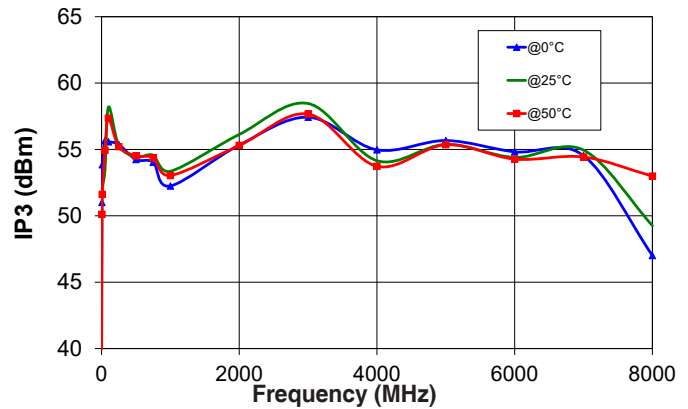

Typical Performance Data*

*at +25°C unless noted otherwise

FREQ. (MHz)	Attenuation relative to I. Loss @ 0°C (dB)									Attenuation relative to I. Loss @ +25°C (dB)									Attenuation relative to I. Loss @ +50°C (dB)								
	@ Attenuation setting (dB)									@ Attenuation setting (dB)									@ Attenuation setting (dB)								
	0.25	5	10	20	40	60	80	90	95	0.25	5	10	20	40	60	80	90	95	0.25	5	10	20	40	60	80	90	95
1	0.31	5.29	10.25	19.92	39.60	58.67	77.83	86.83	91.69	0.30	5.26	10.19	19.83	39.43	58.44	77.79	86.85	91.94	0.29	5.22	10.10	19.71	39.26	58.20	77.47	87.20	92.03
20	0.31	5.29	10.24	19.91	39.59	58.61	77.85	87.20	92.02	0.30	5.26	10.18	19.82	39.43	58.44	77.62	86.91	91.67	0.29	5.21	10.09	19.70	39.25	58.23	77.41	86.72	91.38
100	0.30	5.27	10.22	19.89	39.56	58.58	77.79	87.16	91.96	0.30	5.25	10.16	19.80	39.41	58.41	77.60	86.92	91.73	0.29	5.20	10.08	19.69	39.23	58.22	77.39	86.69	91.41
300	0.30	5.20	10.13	19.78	39.45	58.47	77.65	87.07	91.93	0.29	5.16	10.06	19.68	39.28	58.29	77.47	86.78	91.45	0.29	5.11	9.96	19.55	39.08	58.06	77.23	86.59	91.34
500	0.29	5.08	9.97	19.62	39.29	58.31	77.52	86.87	91.77	0.28	5.04	9.90	19.51	39.11	58.12	77.31	86.62	91.38	0.27	4.99	9.80	19.37	38.90	57.87	77.04	86.38	91.13
700	0.28	4.97	9.84	19.48	39.15	58.17	77.42	86.81	91.47	0.27	4.95	9.78	19.38	38.97	57.97	77.17	86.60	91.25	0.26	4.90	9.68	19.24	38.76	57.72	76.90	86.22	91.01
900	0.27	4.92	9.77	19.40	39.08	58.12	77.37	86.77	91.49	0.27	4.90	9.71	19.30	38.90	57.91	77.14	86.46	91.29	0.26	4.86	9.63	19.17	38.69	57.66	76.85	86.24	90.88
1000	0.27	4.91	9.75	19.39	39.08	58.11	77.38	86.72	91.58	0.26	4.89	9.70	19.30	38.89	57.91	77.14	86.48	91.27	0.26	4.86	9.63	19.17	38.68	57.66	76.87	86.18	90.98
1200	0.27	4.92	9.76	19.40	39.09	58.14	77.43	86.86	91.59	0.26	4.91	9.72	19.31	38.91	57.93	77.20	86.58	91.32	0.26	4.88	9.64	19.19	38.71	57.68	76.96	86.29	90.85
1400	0.27	4.94	9.78	19.42	39.12	58.20	77.52	86.96	91.70	0.26	4.93	9.74	19.34	38.95	57.97	77.25	86.61	91.46	0.26	4.91	9.67	19.23	38.75	57.74	77.05	86.41	91.16
1600	0.26	4.95	9.78	19.43	39.14	58.22	77.57	86.98	91.70	0.26	4.94	9.74	19.34	38.96	58.01	77.39	86.71	91.48	0.25	4.92	9.67	19.24	38.77	57.79	77.08	86.43	91.19
1800	0.26	4.95	9.78	19.43	39.15	58.26	77.63	87.11	91.93	0.26	4.94	9.74	19.35	38.98	58.06	77.45	86.87	91.57	0.25	4.92	9.67	19.24	38.79	57.82	77.21	86.55	91.27
2000	0.26	4.96	9.78	19.44	39.18	58.31	77.77	87.18	91.98	0.26	4.95	9.74	19.36	39.01	58.11	77.57	86.98	91.78	0.25	4.92	9.67	19.25	38.81	57.88	77.27	86.76	91.46
2100	0.26	4.97	9.79	19.46	39.20	58.34	77.83	87.28	92.13	0.26	4.96	9.75	19.38	39.04	58.17	77.62	87.00	91.99	0.25	4.92	9.67	19.27	38.84	57.92	77.38	86.69	91.65
2400	0.26	5.02	9.85	19.54	39.31	58.51	78.08	87.63	92.68	0.26	5.00	9.80	19.45	39.14	58.32	77.88	87.47	92.23	0.25	4.96	9.71	19.34	38.94	58.08	77.63	87.10	91.96
2700	0.27	5.08	9.92	19.64	39.44	58.69	78.36	87.90	92.85	0.26	5.05	9.86	19.56	39.29	58.52	78.19	87.67	92.55	0.26	5.01	9.78	19.45	39.09	58.31	78.03	87.49	92.60
3000	0.27	5.13	9.99	19.75	39.59	58.89	78.71	88.29	93.15	0.27	5.11	9.94	19.67	39.44	58.75	78.55	88.27	93.09	0.26	5.07	9.86	19.57	39.26	58.56	78.34	87.81	92.67
3300	0.28	5.17	10.05	19.86	39.75	59.12	78.99	88.70	93.73	0.27	5.15	10.00	19.78	39.60	59.02	78.92	88.52	93.66	0.27	5.11	9.93	19.67	39.41	58.80	78.72	88.32	93.20
3600	0.28	5.19	10.07	19.93	39.88	59.32	79.41	89.01	94.35	0.28	5.16	10.02	19.85	39.72	59.22	79.30	88.87	94.08	0.27	5.12	9.94	19.72	39.52	59.02	79.15	88.84	93.66
3900	0.28	5.15	10.05	19.94	39.97	59.49	79.80	89.48	94.59	0.28	5.13	9.99	19.85	39.79	59.38	79.68	89.55	94.40	0.27	5.08	9.91	19.72	39.57	59.19	79.50	89.35	94.50
4200	0.28	5.11	9.99	19.94	40.04	59.70	80.05	89.95	94.86	0.28	5.08	9.94	19.84	39.85	59.57	80.10	90.01	94.77	0.27	5.04	9.86	19.71	39.62	59.38	79.85	89.82	94.58
4500	0.28	5.09	9.98	19.97	40.17	59.91	80.50	90.59	95.74	0.27	5.08	9.94	19.88	39.98	59.82	80.49	90.30	95.77	0.27	5.04	9.86	19.75	39.74	59.64	80.36	90.12	95.36
4800	0.27	5.11	10.01	20.05	40.34	60.21	80.98	90.88	95.87	0.27	5.10	9.97	19.96	40.15	60.13	81.02	91.06	96.08	0.27	5.07	9.89	19.83	39.91	59.95	80.82	90.71	95.76
5100	0.27	5.13	10.03	20.12	40.50	60.47	81.34	91.54	96.93	0.27	5.11	9.98	20.03	40.31	60.42	81.40	91.27	96.79	0.26	5.08	9.91	19.91	40.07	60.21	81.26	91.17	96.31
5400	0.27	5.15	10.06	20.21	40.67	60.74	81.80	91.75	96.92	0.27	5.13	10.02	20.12	40.49	60.68	81.80	92.05	96.91	0.26	5.09	9.94	19.99	40.25	60.52	81.69	91.84	97.05
5700	0.29	5.23	10.17	20.38	40.90	61.06	82.05	92.12	97.26	0.28	5.21	10.13	20.30	40.73	61.02	82.16	92.17	97.21	0.28	5.17	10.05	20.17	40.50	60.88	82.22	92.23	97.37
6000	0.31	5.33	10.31	20.56	41.12	61.32	82.32	92.70	98.17	0.30	5.31	10.27	20.50	40.98	61.35	82.55	92.75	97.78	0.30	5.28	10.21	20.39	40.76	61.25	82.59	92.75	98.00
6300	0.33	5.35	10.35	20.64	41.24	61.38	82.31	92.59	97.87	0.32	5.33	10.31	20.57	41.08	61.47	82.56	92.73	98.17	0.32	5.29	10.24	20.45	40.86	61.37	82.79	93.06	98.65
6600	0.33	5.26	10.26	20.57	41.19	61.34	82.15	92.06	97.01	0.32	5.24	10.21	20.49	41.03	61.40	82.44	92.52	97.52	0.32	5.19	10.13	20.36	40.79	61.31	82.47	92.70	98.14
6900	0.32	5.19	10.17	20.50	41.16	61.19	81.73	91.84	97.98	0.31	5.18	10.13	20.43	41.00	61.29	82.06	92.43	97.55	0.31	5.14	10.05	20.30	40.77	61.25	82.22	92.46	97.76
7200	0.31	5.22	10.21	20.57	41.28	61.15	81.50	91.45	96.41	0.31	5.21	10.17	20.50	41.12	61.29	81.80	91.61	97.27	0.30	5.18	10.10	20.39	40.89	61.29	81.92	92.04	97.65
7500	0.31	5.28	10.28	20.69	41.44	61.09	81.06	90.72	95.71	0.31	5.27	10.25	20.62	41.29	61.27	81.43	91.46	96.47	0.30	5.24	10.18	20.50	41.05	61.23	81.60	91.62	96.94
7800	0.31	5.32	10.32	20.77	41.55	60.98	80.43	90.59	95.33	0.31	5.32	10.30	20.71	41.40	61.16	80.83	90.55	96.16	0.31	5.29	10.24	20.59	41.17	61.18	81.19	90.90	95.88
8000	0.32	5.39	10.41	20.87	41.65	60.89	79.91	89.52	94.62	0.32	5.39	10.39	20.81	41.50	61.05	80.46	90.30	94.85	0.32	5.36	10.32	20.69	41.27	61.07	80.68	90.56	95.09

Typical Performance Data(Continued)*

*at +25°C unless noted otherwise

FREQ. (MHz)	Insertion Loss (dB)			VSWR In (:1)											VSWR Out (:1)										
				@ Attenuation setting (dB)											@ Attenuation setting (dB)										
	0°C	25°C	50°C	0	0.25	1	5	10	20	40	60	80	90	95	0	0.25	1	5	10	20	40	60	80	90	95
1	2.68	2.78	2.92	1.73	1.69	1.57	1.38	1.23	1.21	1.15	1.10	1.04	1.04	1.04	1.73	1.68	1.64	1.31	1.21	1.04	1.10	1.05	1.04	1.08	1.10
20	2.73	2.83	2.97	1.71	1.67	1.56	1.38	1.23	1.20	1.14	1.09	1.02	1.02	1.02	1.71	1.67	1.62	1.30	1.20	1.01	1.08	1.02	1.01	1.06	1.08
100	2.82	2.92	3.06	1.70	1.66	1.55	1.37	1.23	1.20	1.14	1.09	1.02	1.02	1.02	1.70	1.65	1.61	1.29	1.20	1.01	1.08	1.01	1.01	1.06	1.08
300	3.08	3.20	3.37	1.57	1.54	1.45	1.33	1.21	1.19	1.14	1.09	1.02	1.02	1.02	1.57	1.55	1.51	1.26	1.19	1.01	1.07	1.02	1.01	1.05	1.07
500	3.37	3.50	3.70	1.39	1.37	1.31	1.26	1.18	1.19	1.14	1.10	1.02	1.03	1.02	1.41	1.40	1.39	1.21	1.17	1.02	1.07	1.02	1.02	1.05	1.07
700	3.64	3.78	3.99	1.22	1.21	1.18	1.20	1.16	1.19	1.14	1.10	1.03	1.04	1.03	1.24	1.25	1.26	1.17	1.17	1.03	1.06	1.03	1.03	1.05	1.07
900	3.84	3.99	4.21	1.09	1.09	1.09	1.16	1.15	1.18	1.14	1.10	1.03	1.04	1.03	1.11	1.13	1.15	1.16	1.17	1.04	1.06	1.04	1.04	1.05	1.06
1000	3.91	4.07	4.28	1.06	1.07	1.09	1.16	1.15	1.18	1.14	1.10	1.04	1.05	1.04	1.08	1.09	1.12	1.16	1.18	1.05	1.06	1.04	1.04	1.05	1.06
1200	4.03	4.19	4.41	1.12	1.12	1.15	1.17	1.14	1.18	1.14	1.11	1.04	1.06	1.04	1.12	1.12	1.13	1.19	1.20	1.06	1.05	1.05	1.05	1.05	1.06
1400	4.15	4.31	4.53	1.17	1.17	1.19	1.18	1.15	1.19	1.15	1.11	1.05	1.06	1.05	1.18	1.18	1.17	1.23	1.23	1.07	1.05	1.06	1.06	1.05	1.05
1600	4.28	4.44	4.67	1.18	1.19	1.20	1.18	1.15	1.19	1.15	1.12	1.06	1.07	1.06	1.19	1.21	1.19	1.25	1.25	1.08	1.04	1.07	1.07	1.05	1.04
1800	4.43	4.60	4.83	1.15	1.16	1.18	1.17	1.15	1.20	1.15	1.12	1.06	1.08	1.06	1.16	1.18	1.16	1.24	1.26	1.09	1.04	1.07	1.07	1.06	1.04
2000	4.57	4.74	4.97	1.12	1.13	1.15	1.16	1.16	1.20	1.16	1.13	1.07	1.09	1.07	1.12	1.13	1.12	1.23	1.25	1.10	1.04	1.08	1.08	1.06	1.04
2100	4.64	4.80	5.04	1.12	1.13	1.14	1.17	1.17	1.20	1.16	1.13	1.07	1.09	1.07	1.11	1.12	1.11	1.23	1.26	1.11	1.04	1.08	1.08	1.06	1.04
2400	4.81	4.98	5.21	1.21	1.21	1.20	1.21	1.19	1.21	1.16	1.14	1.07	1.10	1.08	1.22	1.23	1.23	1.25	1.26	1.12	1.04	1.08	1.08	1.06	1.04
2700	4.98	5.14	5.37	1.34	1.33	1.30	1.27	1.22	1.22	1.16	1.14	1.07	1.09	1.08	1.39	1.42	1.41	1.31	1.29	1.13	1.04	1.08	1.08	1.06	1.04
3000	5.15	5.31	5.52	1.44	1.43	1.38	1.32	1.24	1.22	1.15	1.13	1.07	1.09	1.07	1.51	1.55	1.54	1.35	1.30	1.12	1.05	1.07	1.07	1.05	1.05
3300	5.33	5.49	5.71	1.46	1.44	1.40	1.34	1.24	1.21	1.14	1.12	1.06	1.08	1.06	1.51	1.52	1.52	1.34	1.29	1.12	1.06	1.06	1.06	1.05	1.06
3600	5.57	5.74	5.97	1.37	1.35	1.33	1.29	1.22	1.20	1.13	1.11	1.04	1.06	1.04	1.38	1.37	1.38	1.27	1.25	1.10	1.07	1.06	1.06	1.05	1.07
3900	5.87	6.05	6.30	1.19	1.18	1.18	1.21	1.17	1.17	1.10	1.10	1.02	1.04	1.02	1.19	1.18	1.21	1.20	1.21	1.09	1.09	1.07	1.07	1.06	1.09
4200	6.20	6.39	6.65	1.04	1.04	1.07	1.14	1.13	1.15	1.08	1.08	1.02	1.04	1.01	1.07	1.10	1.11	1.16	1.18	1.08	1.11	1.10	1.10	1.08	1.11
4500	6.47	6.67	6.95	1.10	1.10	1.10	1.10	1.11	1.12	1.06	1.07	1.04	1.06	1.03	1.10	1.11	1.09	1.14	1.15	1.07	1.13	1.13	1.13	1.11	1.13
4800	6.71	6.91	7.20	1.12	1.12	1.11	1.08	1.10	1.09	1.05	1.06	1.07	1.09	1.06	1.09	1.07	1.05	1.11	1.11	1.07	1.15	1.17	1.17	1.14	1.16
5100	6.96	7.16	7.46	1.07	1.07	1.06	1.04	1.08	1.06	1.06	1.06	1.11	1.13	1.10	1.05	1.04	1.03	1.06	1.07	1.07	1.17	1.21	1.21	1.18	1.18
5400	7.19	7.40	7.70	1.07	1.06	1.05	1.04	1.07	1.04	1.09	1.08	1.15	1.17	1.14	1.07	1.06	1.06	1.06	1.07	1.10	1.20	1.25	1.25	1.22	1.21
5700	7.35	7.56	7.86	1.09	1.08	1.07	1.05	1.06	1.05	1.13	1.11	1.19	1.23	1.18	1.06	1.02	1.02	1.10	1.13	1.16	1.24	1.29	1.29	1.26	1.25
6000	7.49	7.70	8.00	1.06	1.05	1.03	1.04	1.07	1.09	1.17	1.15	1.24	1.28	1.23	1.08	1.12	1.11	1.19	1.21	1.23	1.27	1.33	1.33	1.31	1.29
6300	7.76	7.99	8.31	1.09	1.09	1.07	1.07	1.10	1.14	1.23	1.20	1.31	1.36	1.30	1.34	1.35	1.33	1.34	1.32	1.31	1.32	1.37	1.37	1.36	1.32
6600	8.19	8.45	8.80	1.23	1.23	1.20	1.15	1.16	1.19	1.29	1.25	1.38	1.44	1.37	1.58	1.58	1.55	1.49	1.43	1.39	1.36	1.39	1.39	1.40	1.36
6900	8.63	8.88	9.24	1.31	1.31	1.28	1.22	1.21	1.24	1.35	1.31	1.46	1.53	1.45	1.67	1.66	1.65	1.57	1.51	1.46	1.40	1.41	1.41	1.45	1.40
7200	8.95	9.19	9.56	1.30	1.30	1.29	1.28	1.26	1.29	1.41	1.37	1.55	1.63	1.53	1.61	1.60	1.62	1.58	1.55	1.50	1.43	1.41	1.41	1.48	1.43
7500	9.24	9.49	9.86	1.37	1.36	1.36	1.39	1.33	1.36	1.46	1.42	1.63	1.73	1.61	1.62	1.61	1.63	1.58	1.58	1.51	1.45	1.39	1.39	1.49	1.44
7800	9.63	9.86	10.22	1.53	1.52	1.53	1.54	1.44	1.46	1.52	1.47	1.70	1.82	1.68	1.71	1.69	1.69	1.62	1.62	1.52	1.45	1.35	1.35	1.49	1.44
8000	9.88	10.10	10.46	1.61	1.61	1.63	1.65	1.53	1.53	1.55	1.50	1.74	1.87	1.72	1.69	1.67	1.67	1.64	1.65	1.53	1.44	1.32	1.32	1.47	1.43

Software & Documentation Download:

- Mini-Circuits' full software and support package including user guide, Windows GUI, DLL files, programming manual and examples can be downloaded free of charge from <http://www.minicircuits.com/softwaredownload/patt.html>
- Please contact testsolutions@minicircuits.com for support

Minimum System Requirements

Parameter	Requirements	
Interface	USB HID or HTTP Get/Post or Telnet protocols or SSH	
System requirements	GUI:	Windows 32 & 64 bit systems from Windows 98 up to Windows 10
	USB API (ActiveX & .Net)	Windows 32 & 64 bit systems with ActiveX or .Net support from Windows 98 up to Windows 10
	USB direct programming support	Linux, Windows systems from Windows 98 up to Windows 10
	HTTP, Telnet or SSH	Any computer with a network port and Ethernet-TCP/IP (HTTP, Telnet or SSH protocols) support
Hardware	Pentium® II or higher, RAM 256 MB	

Graphical User Interface (GUI) for Windows

Key Features:

- Manual attenuation setting
- Sweep and Hop attenuation sequences directed from the PC, or entire sequence loaded into RC8DAT.
- Attenuator address configuration and Firmware upgrade
- Attenuation at power up may be set to selected attenuation level or last attenuation state recorded.
- Maintain Log of commands sent to attenuator.
- USB, HTTP, Telnet or SSH control of RC8DAT
- Setting Ethernet configuration

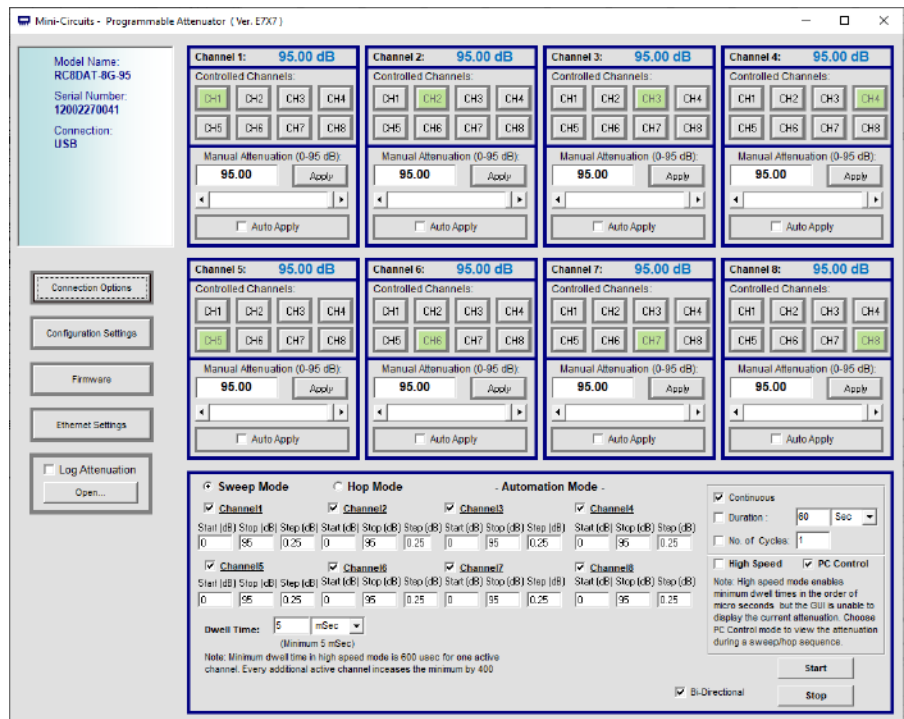

Application Programming Interface (API)

Programming manual: https://www.minicircuits.com/softwaredownload/Prog_Manual-6-Programmable_Attenuator.pdf

Windows Support:



- API DLL files exposing the full switch functionality
 - ActiveX COM DLL file for creation of 32-bit programs
 - .Net library DLL file for creation of 32 / 64-bit programs
- Supported by most common programming environments (refer to application note [AN-49-001](#) for summary of tested environments)

Linux Support:

- Full attenuator control in a Linux environment is achieved by way of USB interrupt commands.

Ordering Information

Model	Description
RC8DAT-8G-95	USB/Ethernet eight channel Programmable Attenuator

Included Accessories	Part No.	Description
	USB-CBL-AC-3+	3.3 ft (1.0 m) USB Cable: USB type A(Male) to USB type C(Male)
	BKT-355-05+	Bracket kit including two 2.5" x 0.35" side mounting brackets and screws

Optional Accessories	Description
USB-AC/DC-5	AC/DC 5V _{DC} Power Adapter with US, EU, IL, UK, AUS, and China power plugs ^{12,13}
USB-CBL-AC-3+ (spare)	3.3 ft (1.0 m) USB Cable: USB type A(Male) to USB type C(Male)
USB-CBL-AA-3+	3.3 ft (1.0 m) USB extension Cable: USB type A(Male) to USB type A(Female)
CBL-RJ45-MM-5+	5 ft (1.5 m) Ethernet cable: RJ45(Male) to RJ45(Male) Cat 5E cable
BKT-355-05+ (spare)	Bracket kit including two 2.5" x 0.35" side mounting brackets and screws

¹² The USB-AC/DC-5 may be used to provide the 5V_{DC} power input via USB port if operating the RC8DAT with Ethernet control. Not required if using USB control.

¹³ Power plugs for other countries are also available, if you need a power plug for a country not listed please contact testsolutions@minicircuits.com

Additional Notes

- A. Performance and quality attributes and conditions not expressly stated in this specification document are intended to be excluded and do not form a part of this specification document.
- B. Electrical specifications and performance data contained in this specification document are based on Mini-Circuit's applicable established test performance criteria and measurement instructions.
- C. The parts covered by this specification document are subject to Mini-Circuits standard limited warranty and terms and conditions (collectively, "Standard Terms"); Purchasers of this part are entitled to the rights and benefits contained therein. For a full statement of the Standard Terms and the exclusive rights and remedies thereunder, please visit Mini-Circuits' website at www.minicircuits.com/MCLStore/terms.jsp

